



## 150V/20A N-Channel Advanced Power MOSFET

### Features

- Improved dv/dt Capability, High Ruggedness.
- Maximum Junction Temperature Range (150°C)
- 100% Avalanche Tested

BVDSS	150	V
ID	20	A
RDSON@VGS=10V	57	mΩ
RDSON@VGS=4.5V	65	mΩ

### Applications

- TV Power
- LED Lighting Power
- DC/DC Converter

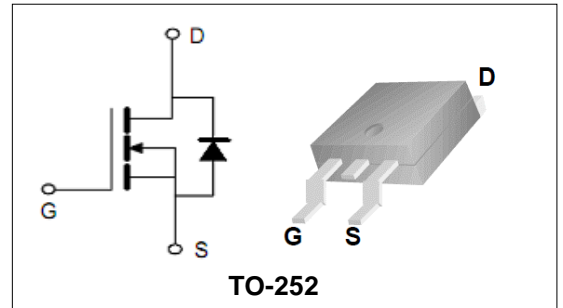

### Order Information

Product	Package	Marking	Reel Size	Reel	Carton
PTD20G15	TO-252	PTD20G15	13inch	2500PCS	50000PCS

### Absolute Maximum Ratings

Symbol	Parameter	Rating	Unit	
<b>Common Ratings (TC=25°C Unless Otherwise Noted)</b>				
$V_{(BR)DSS}$	Drain-Source Breakdown Voltage	150	V	
$V_{GS}$	Gate-Source Voltage	±20	V	
$T_J$	Maximum Junction Temperature	150	°C	
$T_{STG}$	Storage Temperature Range	-55 to 150	°C	
$I_S$	Diode Continuous Forward Current	TC =25°C	20	A
<b>Mounted on Large Heat Sink</b>				
$E_{AS}$	Single Pulse Avalanche Energy (Note1)	25	mJ	
$I_{DM}$	Pulse Drain Current Tested (Silicon Limit) (Note2)	TC =25°C	73	A
$I_D$	Continuous Drain current	TC =25°C	20	A
$P_D$	Maximum Power Dissipation	TC =25°C	57	W
$R_{θJC}$	Thermal Resistance Junction-to-Case (Note3)	2.2	°C/W	
$R_{θJA}$	Thermal Resistance Junction-to-Ambient (Note3)	62	°C/W	

**150V/20A N-Channel Advanced Power MOSFET**

Symbol	Parameter	Condition	Min.	Typ.	Max.	Unit
<b>Static Electrical Characteristics @ T<sub>J</sub> = 25°C (unless otherwise stated)</b>						
V <sub>(BR)DSS</sub>	Drain- Source Breakdown Voltage	VGS=0V ID=250μA	150	--	--	V
I <sub>DSS</sub>	Zero Gate Voltage Drain current	VDS=150V,VGS=0V	--	--	1	μA
I <sub>GSS</sub>	Gate-Body Leakage Current	VGS=±20V,VDS=0V	--	--	±100	nA
V <sub>GS(TH)</sub>	Gate Threshold Voltage	VDS=VGS,ID=250μA	1.4	2	2.5	V
R <sub>DS(ON)</sub>	Drain-Source On-State Resistance (Note4)	VGS=10V, ID=10A	--	57	75	mΩ
		VGS=4.5V, ID=10A	--	65	90	mΩ
<b>Dynamic Electrical Characteristics @ T<sub>J</sub> = 25°C (unless otherwise stated) (Note5)</b>						
C <sub>iss</sub>	Input Capacitance	VDS=75V, VGS=0V, F=1MHz	--	566	--	pF
C <sub>oss</sub>	Output Capacitance		--	61	--	pF
C <sub>rss</sub>	Reverse Transfer Capacitance		--	2.4	--	pF
Q <sub>g</sub>	Total Gate Charge	VDS=75V, ID=10A, VGS=10V	--	2.5	--	nC
Q <sub>gs</sub>	Gate-Source Charge		--	1.2	--	nC
Q <sub>gd</sub>	Gate-Drain Charge		--	7	--	nC
<b>Switching Characteristics (Note5)</b>						
t <sub>d(on)</sub>	Turn-on Delay Time	VDD=75V, ID=10A, VGS=10V, RG=1.6Ω	--	9	--	nS
t <sub>r</sub>	Turn-on Rise Time		--	7	--	nS
t <sub>d(off)</sub>	Turn-off Delay Time		--	13	--	nS
t <sub>f</sub>	Turn-off Fall Time		--	4	--	nS
<b>Source- Drain Diode Characteristics @ T<sub>J</sub> = 25°C (unless otherwise stated)</b>						
V <sub>SD</sub>	Forward on voltage	IS=10A,VGS=0V	--	0.86	1	V

Note:

- Limited by T<sub>Jmax</sub>, starting T<sub>J</sub> = 25° C, R<sub>G</sub> = 25Ω, V<sub>D</sub> =50V, V<sub>G</sub>S =10V. Part not recommended for use above this value.
- Repetitive Rating: Pulse width limited by maximum junction temperature.
- Surface Mounted on FR4 Board, t ≤ 10 sec.
- Pulse Test: pulse width ≤ 300 us, duty cycle ≤ 2%.
- Guaranteed by design, not subject to production testing.



150V/20A N-Channel Advanced Power MOSFET

Typical Characteristics

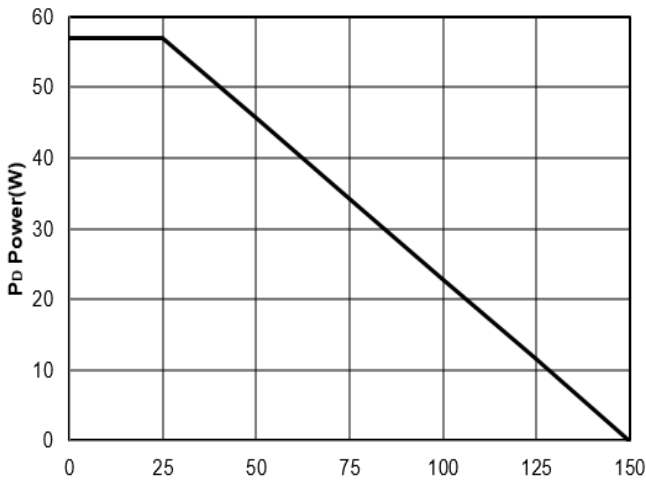

Figure1: Tj Junction Temperature (°C)

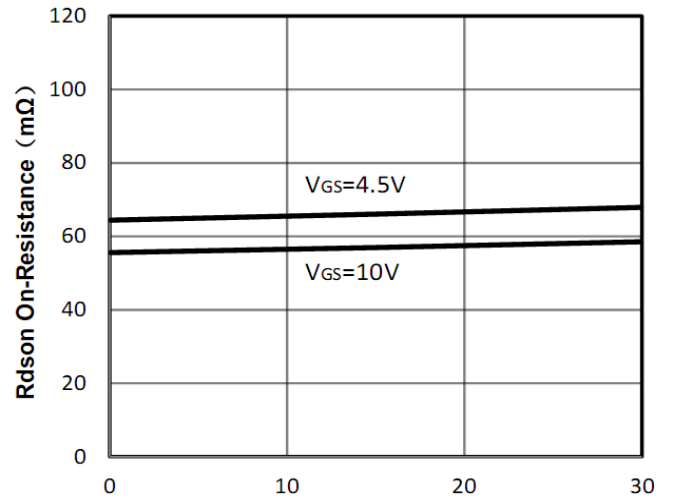

Figure2: Id Drain Current (A)

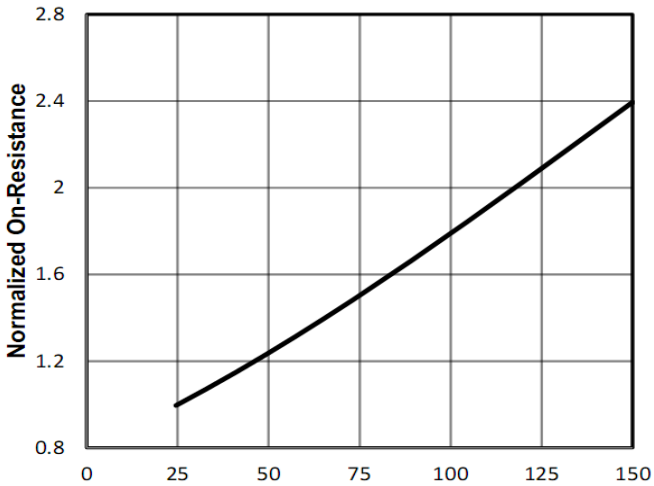

Figure3: Tj Junction Temperature (°C)

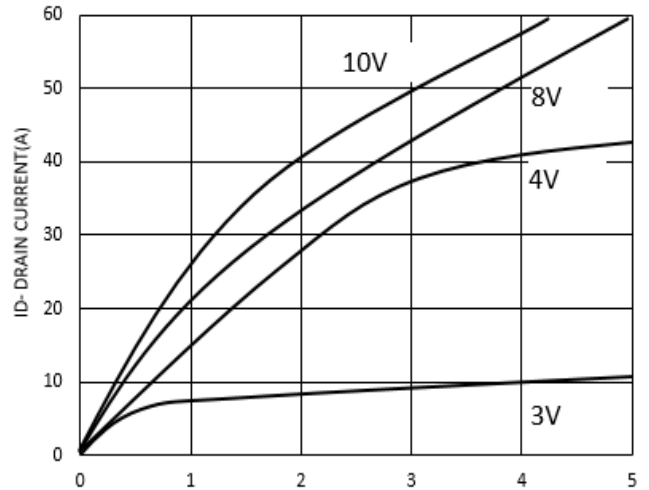

Figure4: Vds Drain-Source Voltage (A)

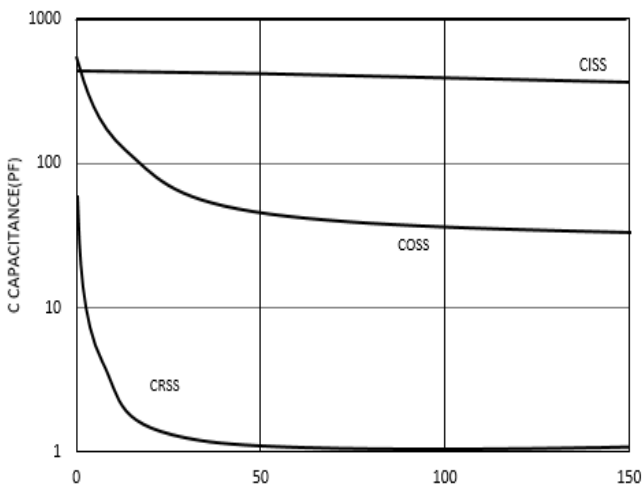

Figure5: Vds Draun-Source Voltage (V)

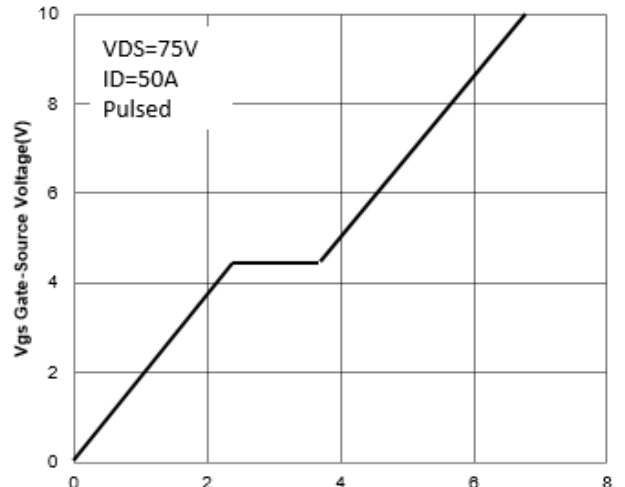

Figure6: Qg Gate Charge (nC)



150V/20A N-Channel Advanced Power MOSFET

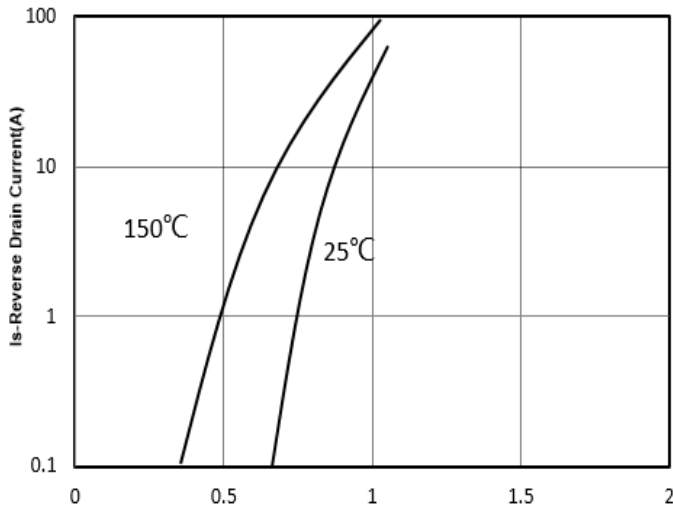

Figure7: Vsd Source-Drain Voltage (V)

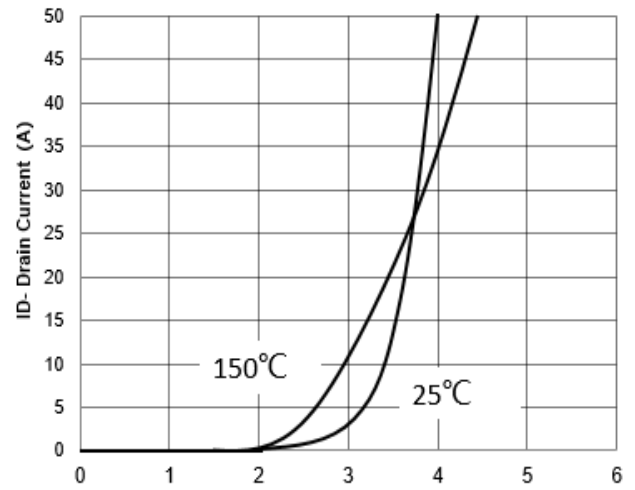

Figure8: Vgs Gate-Source Voltage (V)

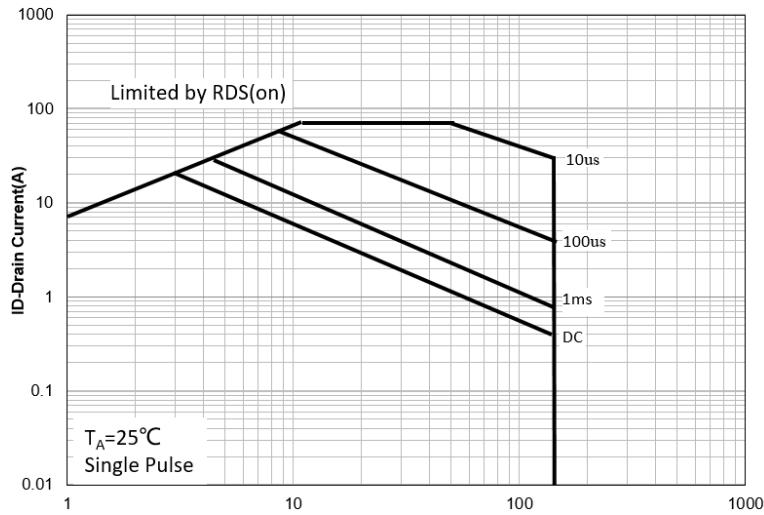

Figure9: Vds Drain -Source Voltage (V)

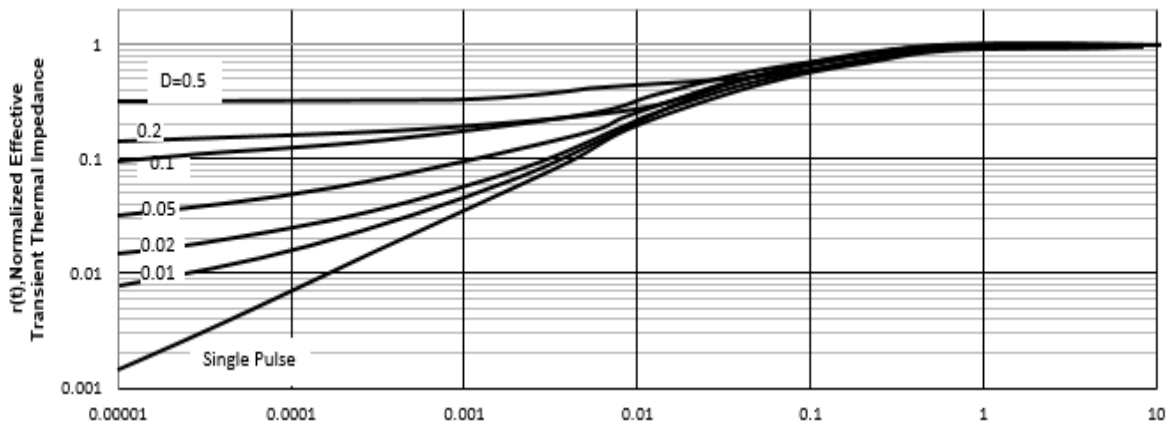

Figure10: Square Wave Pulse Duration (sec)

## 150V/20A N-Channel Advanced Power MOSFET

### Test Circuit and Waveform:

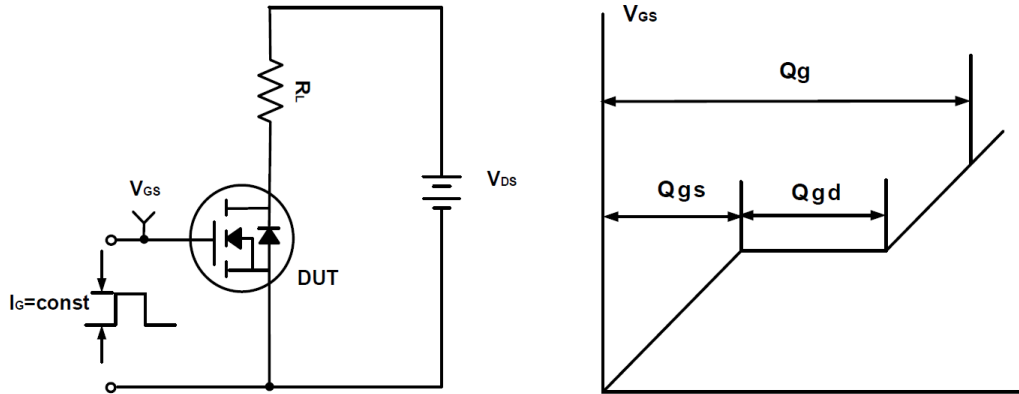

Figure A Gate Charge Test Circuit & Waveforms

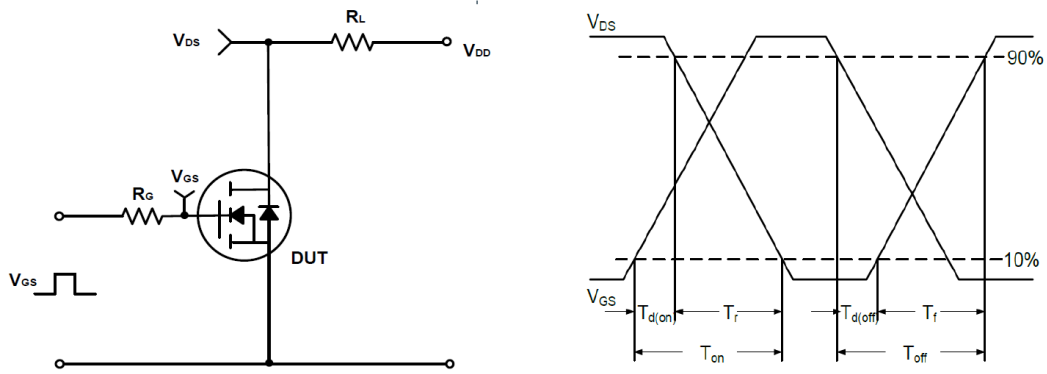

Figure B Switching Test Circuit & Waveforms

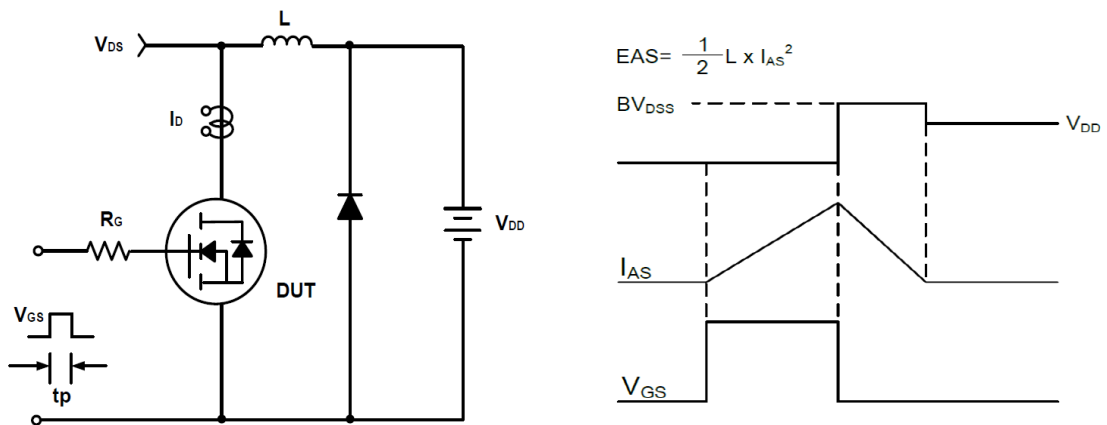
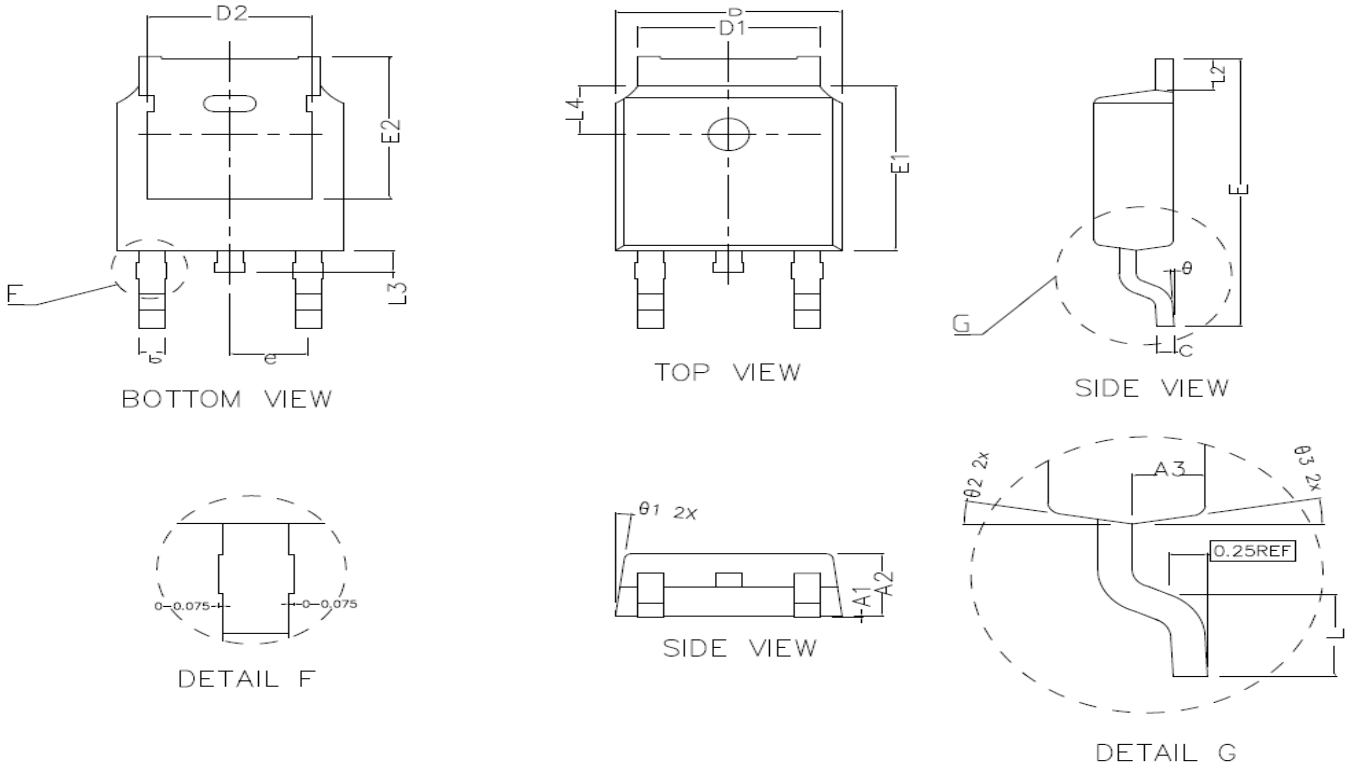

Figure C Unclamped Inductive Switching Circuit & Waveforms



150V/20A N-Channel Advanced Power MOSFET

TO-252 Package Outline Dimensions (Units: mm)



COMMON DIMENSIONS (UNITS OF MEASURE IS mm)			
	MIN	NORMAL	MAX
A1	0.000	0.100	0.150
A2	2.200	2.300	2.400
A3	1.020	1.070	1.120
b	0.710	0.760	0.810
c	0.460	0.508	0.550
D	6.500	6.600	6.700
D1	5.330REF		
D2	4.830REF		
E	9.900	10.100	10.300
E1	6.000	6.100	6.200
E2	5.600REF		
e	2.286TYPE		
L	1.400	1.550	1.700
L2	1.10REF		
L3	0.80REF		
L4	1.80REF		
$\theta$	0~8°		
$\theta 1$	7° TYPE		
$\theta 2$	10° TYPE		
$\theta 3$	10° TYPE		