



N-Channel Super Junction Power MOSFET

Features

- New technology for high voltage device.
- Low on-resistance and low conduction losses
- Ultra Low Gate Charge cause lower driving requirements
- 100% Avalanche Tested

BVDSS	650	V
ID	78	A
RDSON@VGS=10V	33	mΩ

Applications

- Power factor correction (PFC)
- Switched mode power supplies(SMPS)
- Uninterruptible Power Supply (UPS)

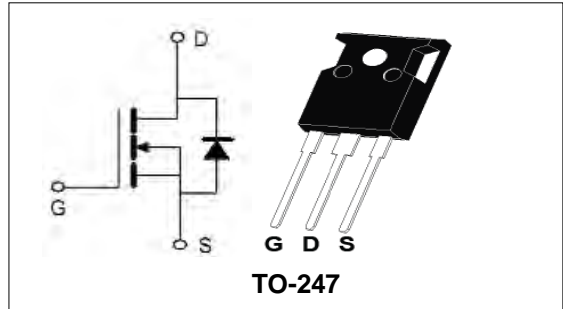

Package Markin and Ordering Information

Device	Package	Marking	Units/Tube
PJW65R041	TO-247	PJW65R041	30

Absolute Maximum Ratings (TA=25°C)

Parameter	Symbol	Value	Unit
Drain-Source Voltage	V _{DS}	650	V
Gate-Source Voltage	V _{GS}	±30	V
Continuous Drain Current at Tc=25°C	I _{D(DC)}	78	A
Pulsed drain current (Note 1)	I _{DM(pluse)}	234	A
Maximum Power Dissipation(Tc=25°C)	P _D	500	W
Continuous Diode Forward Current	I _S	78	A
Single pulse avalanche energy (Note 2)	E _{AS}	2360	mJ
Operating Junction and Storage Temperature Range	T _J , T _{STG}	-55...+150	°C
Thermal Resistance, Junction-to-Case	R _{thJC}	0.25	°C/W



N-Channel Super Junction Power MOSFET

Electrical Characteristics (T_J=25 °C unless otherwise noted)

Parameter	Symbol	Condition	Min	Typ	Max	Unit
On/off states						
Drain-Source Breakdown Voltage	BV _{DSS}	V _{GS} =0V I _D =250μA	650			V
Zero Gate Voltage Drain Current	I _{DSS}	V _{DS} =650V, V _{GS} =0V			10	μA
Gate-Body Leakage Current	I _{GSS}	V _{GS} =±30V, V _{DS} =0V			±100	nA
Gate Threshold Voltage	V _{GS(th)}	V _{DS} =V _{GS} , I _D =250uA	3	4	5	V
Drain-Source On-State Resistance	R _{DS(ON)}	V _{GS} =10V, I _D =40A		33	41	mΩ
Dynamic Characteristics						
Input Capacitance	C _{iss}	V _{DS} =100V, V _{GS} =0V, F=1MHz		6070		pF
Output Capacitance	C _{oss}			220		pF
Reverse Transfer Capacitance	C _{rss}			3.5		pF
Total Gate Charge	Q _g	V _{DS} =480V, I _D =30A, V _{GS} =10V		103		nC
Gate-Source Charge	Q _{gs}			26.2		nC
Gate-Drain Charge	Q _{gd}			30.1		nC
Switching times						
Turn-on Delay Time	t _{d(on)}	V _{DS} = 300 V, I _D = 30 A, V _{GS} = 10 V, R _{GEN} = 25 Ω		64		nS
Turn-on Rise Time	t _r			69		nS
Turn-Off Delay Time	t _{d(off)}			307		nS
Turn-Off Fall Time	t _f			56		nS
Source- Drain Diode Characteristics						
Forward On Voltage	V _{SD}	T _j =25°C, I _{SD} =40A, V _{GS} =0V			1.2	V
Reverse Recovery Time	t _{rr}	VR=400V I _F = 20 A, dI/dT = 100 A/μS		165		nS
Reverse Recovery Charge (Note 3)	Q _{rr}			1.35		μC
Peak Reverse Recovery Current	I _{rrm}			15		A

Notes 1. Repetitive Rating: Pulse width limited by maximum junction temperature

2. V_{DD} = 50V, V_{GS}=10V, R_G = 25 Ω

3. Pulse width ≤ 300us, duty cycle ≤ 2%



N-Channel Super Junction Power MOSFET

Typical Characteristics

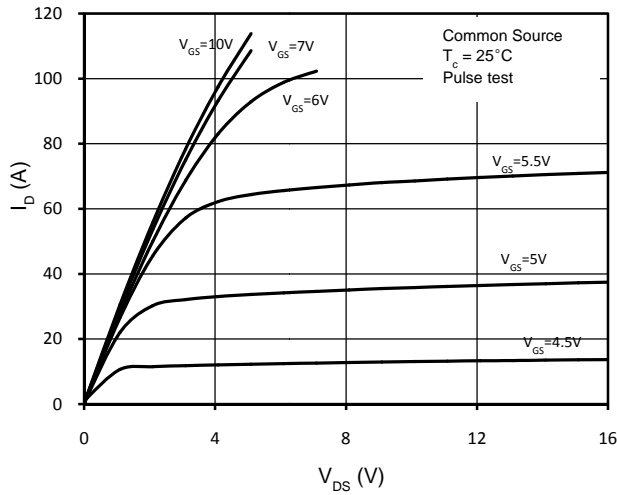

Figure 1. On-Region Characteristics

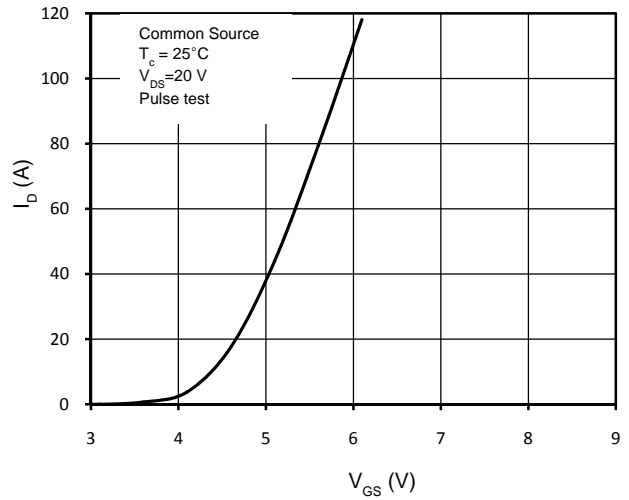

Figure 2. Transfer Characteristics

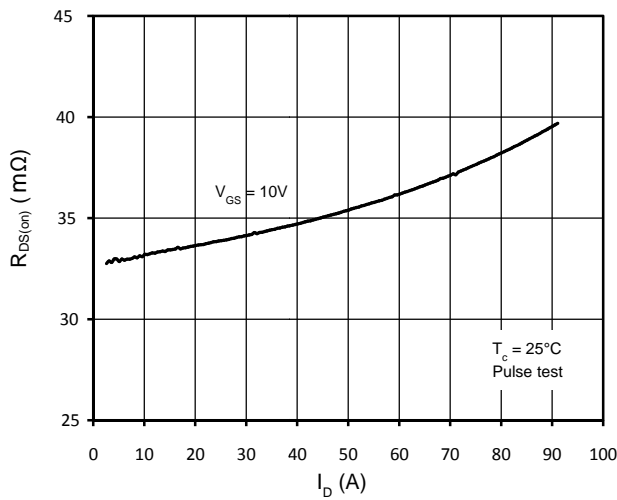

Figure 3. Static Drain-Source On Resistance

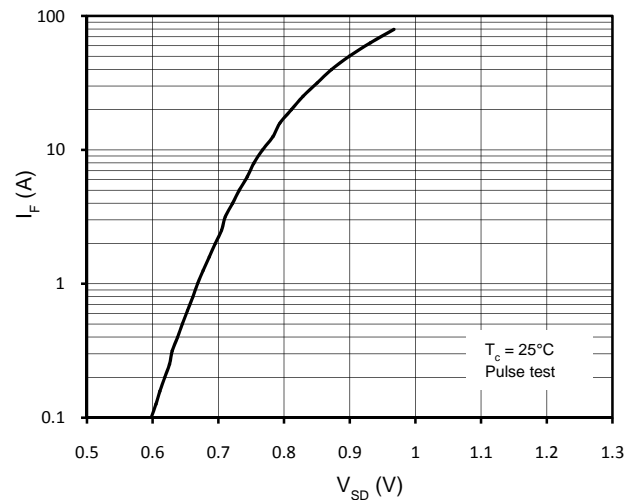

Figure 4. Body-Diode Forward Characteristics

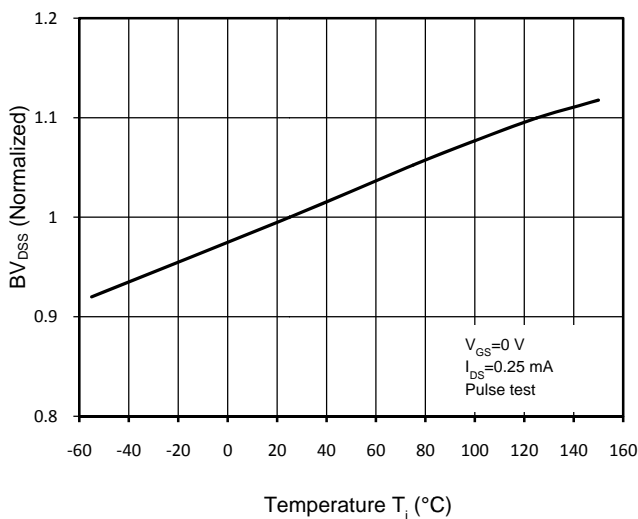

Figure 5. Normalized BV_{DS} vs. Temperature

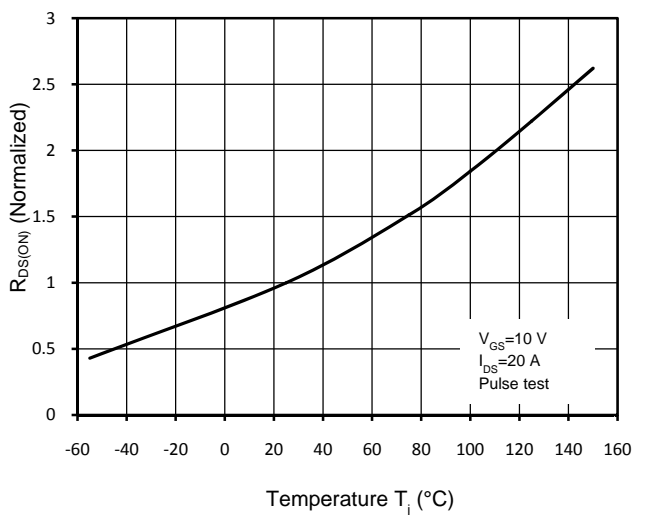

Figure 6. Normalized $R_{DS(on)}$ vs. Temperature

N-Channel Super Junction Power MOSFET

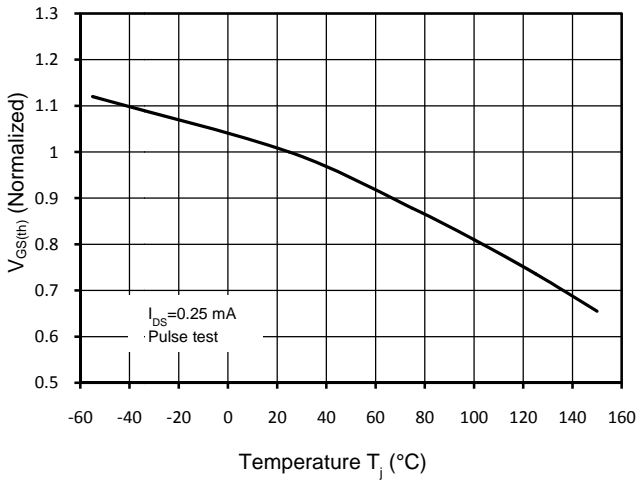

Figure 7. Threshold Voltage vs. Temperature

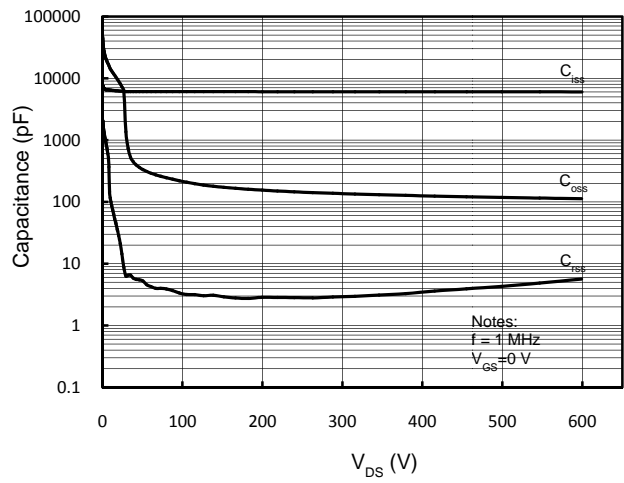

Figure 8. Capacitance Characteristics

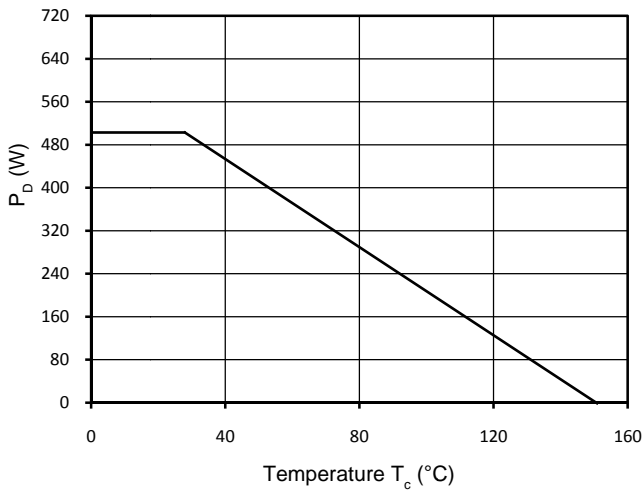

Figure 9. Power Dissipation

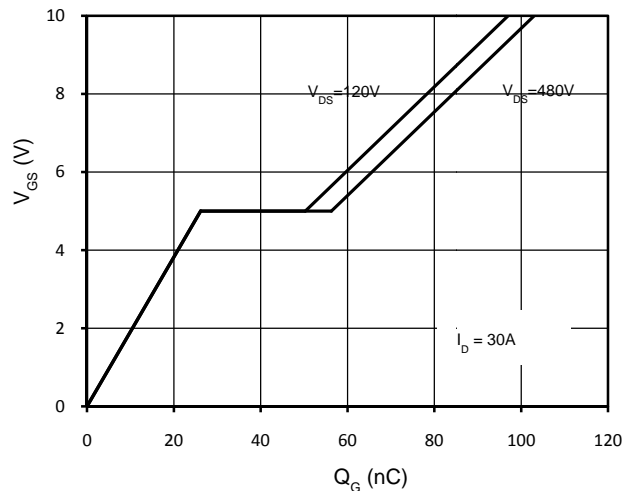

Figure 10. Gate Charge Characteristics

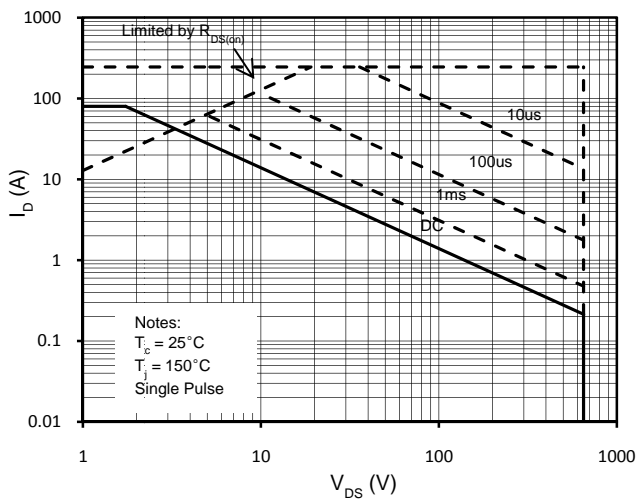

Figure 11. Maximum Safe Operating Area

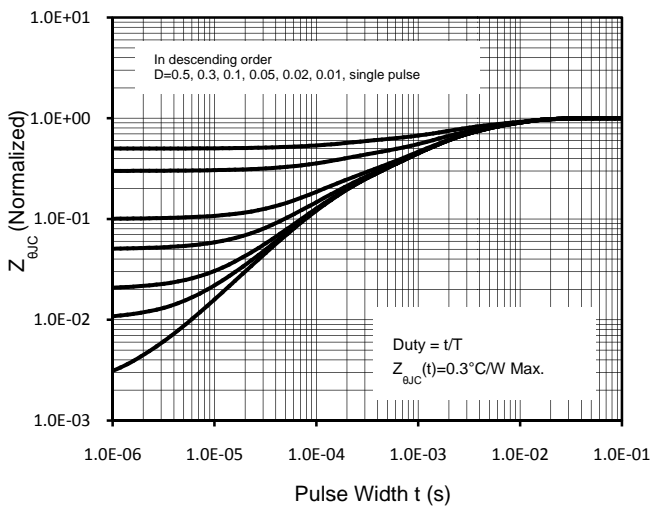
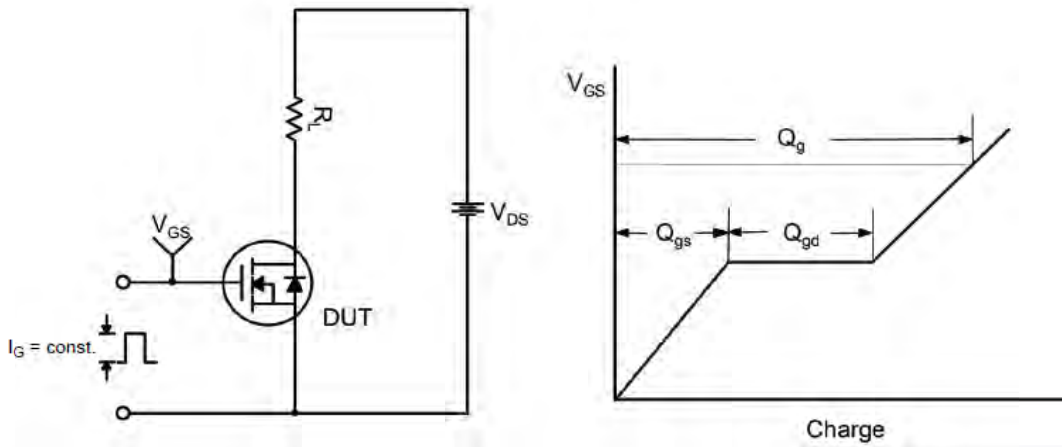

Figure 12. Transient Thermal Response Curve

N-Channel Super Junction Power MOSFET

Gate Charge Test Circuit & Waveform



Switching Test Circuit & Waveforms

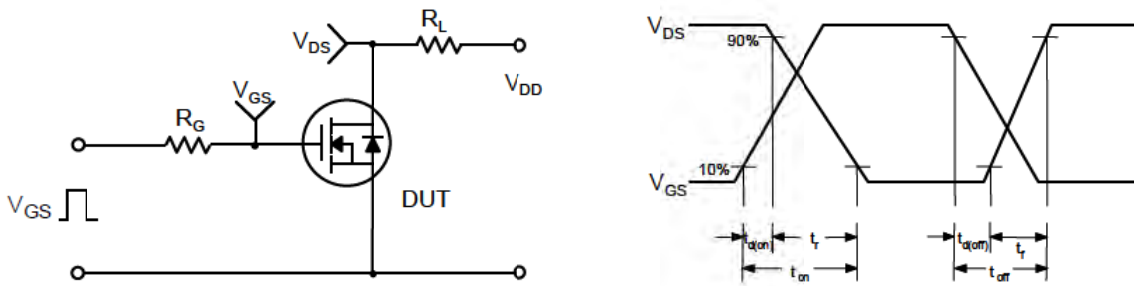

Unclamped Inductive Switching Test Circuit & Waveforms

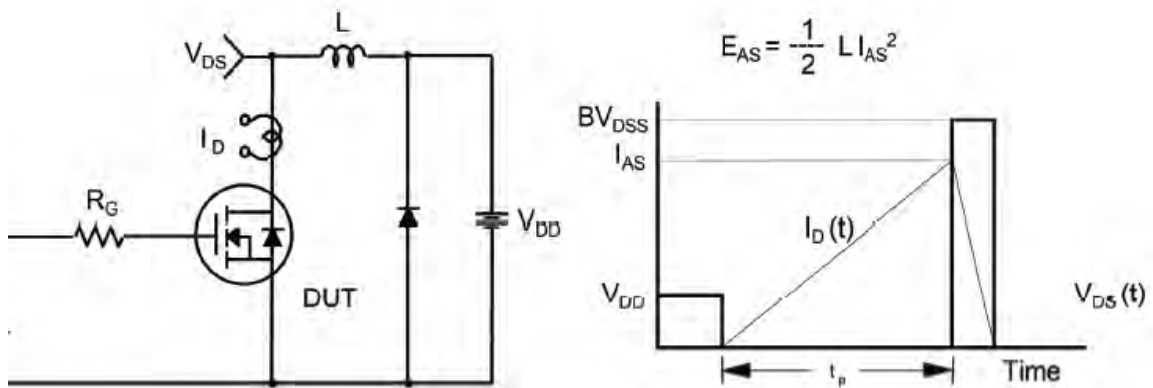

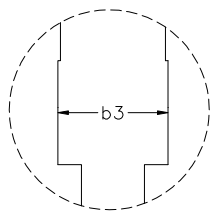
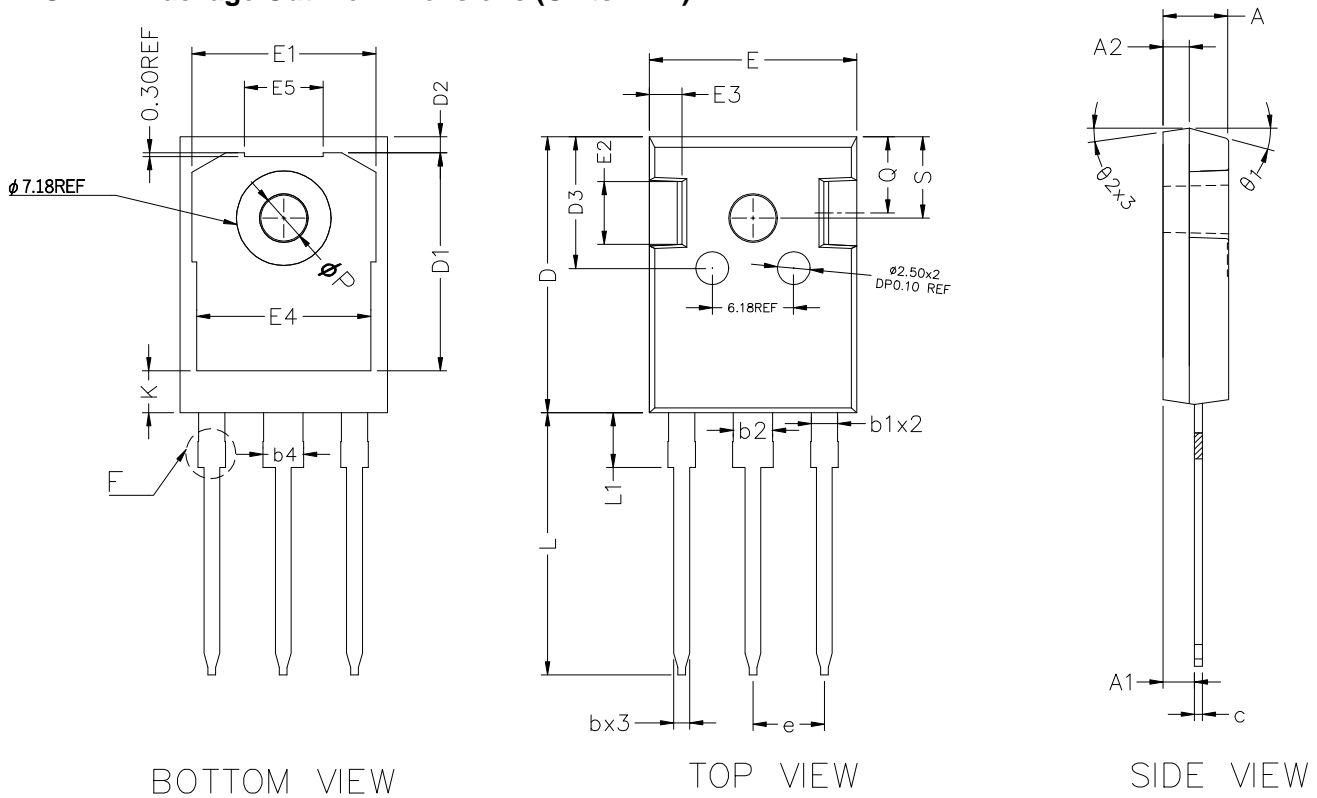
N-Channel Super Junction Power MOSFET
TO-247 Package Outline Dimensions (Units: mm)

DETAIL F

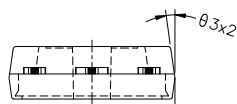

SIDE VIEW

**COMMON DIMENSIONS
(UNITS OF MEASURE IS mm)**

	MIN	NORMAL	MAX
A	4.900	5.000	5.100
A1	2.300	2.400	2.500
A2	1.900	2.000	2.100
b	1.070	1.200	1.330
b1	1.910	2.000	2.160
b2	2.870	3.000	3.160
b3	1.910	2.100	2.410
b4	2.870	3.000	3.380
c	0.550	0.600	0.680
D	20.000	21.000	21.100
D1	16.250	16.950	17.650
D2	1.200REF		
D3	10.000REF		
E	15.700	15.800	15.900
E1	13.100	14.020	14.150
E2	3.680	—	5.100
E3	1.000	—	1.900
E4	12.380	13.260	13.430
E5	5.990REF		
e	5.440BSC		
L	19.810	19.950	20.320
L1	4.100	—	4.400
φP	3.500	—	3.650
Q	5.490	—	6.000
S	6.040	—	6.300
θ1	15.0°REF		
θ2	8.0°REF		
θ3	8.0°REF		
K	3.190REF		