



650V/7A N-Channel Junction Power MOSFET

Features

- New technology for high voltage device.
- Low on-resistance and low conduction losses
- Small package
- Ultra Low Gate Charge cause lower driving requirements
- 100% Avalanche Tested

BVDSS	650	V
ID	7	A
RDSON@VGS=10V	510	mΩ

Applications

- Power factor correction (PFC)
- Switched mode power supplies(SMPS)
- Uninterruptible Power Supply (UPS)

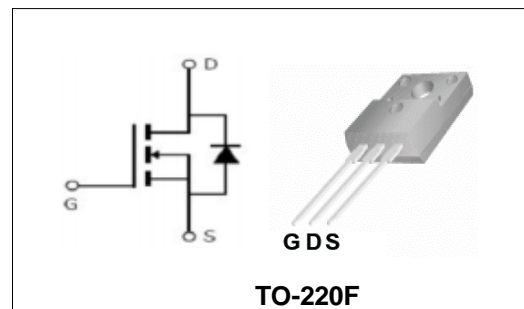

Order Information

Product	Package	Marking	Tube	Carton
PJF65R650	TO-220F	PJF65R650	50PCS	5000PCS

Absolute Maximum Ratings

Symbol	Parameter	Rating	Unit
Common Ratings (TC=25°C Unless Otherwise Noted)			
$V_{(BR)DSS}$	Drain-Source Breakdown Voltage	650	V
V_{GS}	Gate-Source Voltage	±30	V
T_J	Maximum Junction Temperature	150	°C
T_{STG}	Storage Temperature Range	-55 to 150	°C
I_S	Diode Continuous Forward Current	TC =25°C 7	A
Mounted on Large Heat Sink			
E_{AS}	Single Pulse Avalanche Energy (Note1)	121	mJ
I_{DM}	Pulse Drain Current Tested (Silicon Limit) (Note2)	TC =25°C 28	A
I_D	Continuous Drain current	TC =25°C 7	A
P_D	Maximum Power Dissipation	TC =25°C 26	W
$R_{\theta JC}$	Thermal Resistance Junction-to-Case (Note3)	4.8	°C/W

**650V/7A N-Channel Junction Power MOSFET**

Symbol	Parameter	Condition	Min.	Typ.	Max.	Unit
Static Electrical Characteristics @ T_J = 25°C (unless otherwise stated)						
V _{(BR)DSS}	Drain- Source Breakdown Voltage	VGS=0V ID=250μA	650	--	--	V
I _{DSS}	Zero Gate Voltage Drain current	VDS=650V,VGS=0V	--	--	1	μA
I _{GSS}	Gate-Body Leakage Current	VGS=±30V,VDS=0V	--	--	±100	nA
V _{GS(TH)}	Gate Threshold Voltage	VDS=VGS,ID=250μA	2	--	4	V
R _{DS(ON)}	Drain-Source On-State Resistance (Note4)	VGS=10V, ID=3.5A	--	510	650	mΩ
Dynamic Electrical Characteristics @ T_J = 25°C (unless otherwise stated) (Note5)						
C _{iss}	Input Capacitance	VDS=25V, VGS=0V, F=1MHz	--	466	--	pF
C _{oss}	Output Capacitance		--	395	--	pF
C _{rss}	Reverse Transfer Capacitance		--	50	--	pF
Q _g	Total Gate Charge	VDS=520V, ID=7A, VGS=10V	--	19.7	--	nC
Q _{gs}	Gate-Source Charge		--	4.1	--	nC
Q _{gd}	Gate-Drain Charge		--	7.0	--	nC
Switching Characteristics (Note5)						
t _{d(on)}	Turn-on Delay Time	VDD=325V, RL=150Ω, VGS=10V RG=10Ω	--	12.4	--	nS
t _r	Turn-on Rise Time		--	2	--	nS
t _{d(off)}	Turn-off Delay Time		--	56.4	--	nS
t _f	Turn-off Fall Time		--	11.2	--	nS
Source- Drain Diode Characteristics @ T_J = 25°C (unless otherwise stated)						
V _{SD}	Forward on voltage	IS=7A,VGS=0V	--	0.9	1.5	V

Note:

- Limited by T_{Jmax}, starting T_J = 25° C, R_G = 25Ω, V_D = 50V, V_{GS} = 10V. Part not recommended for use above this value.
- Repetitive Rating: Pulse width limited by maximum junction temperature.
- Surface Mounted on FR4 Board, t ≤ 10 sec.
- Pulse Test: pulse width ≤ 300 us, duty cycle ≤ 2%.
- Guaranteed by design, not subject to production testing.



650V/7A N-Channel Junction Power MOSFET

Typical Characteristics

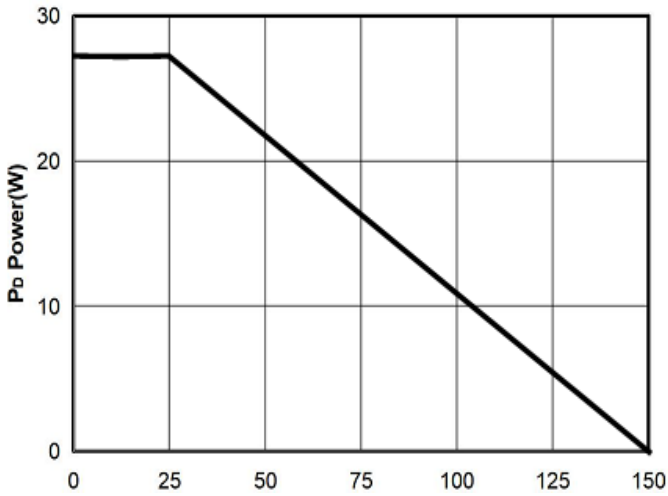

Figure1: Tj Junction Temperature (°C)

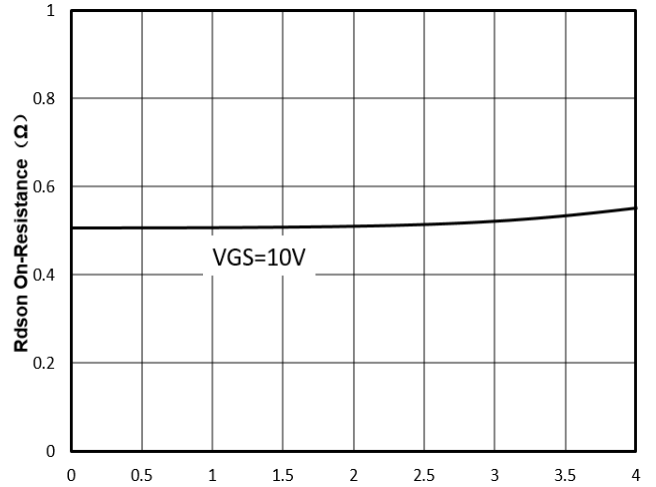

Figure2: Id Drain Current (A)

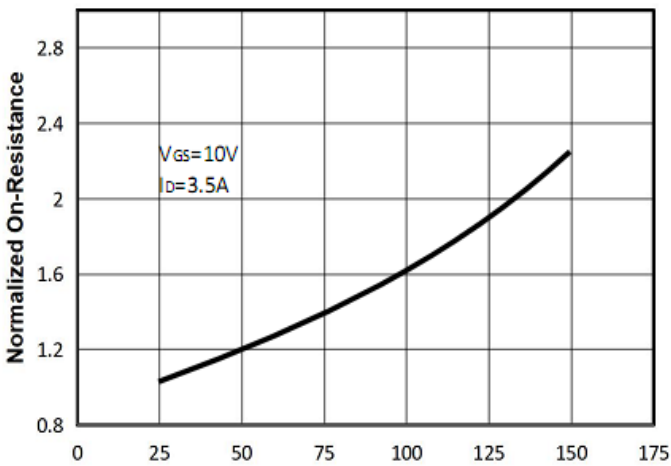

Figure3: Tj Junction Temperature (°C)

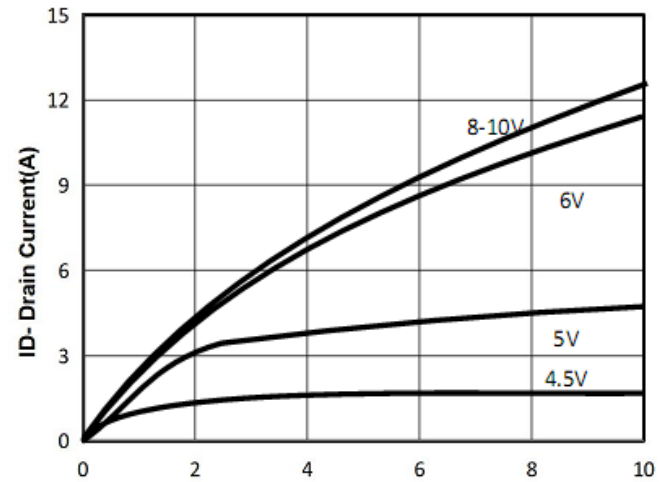

Figure4: Vds Drain-Source Voltage (V)

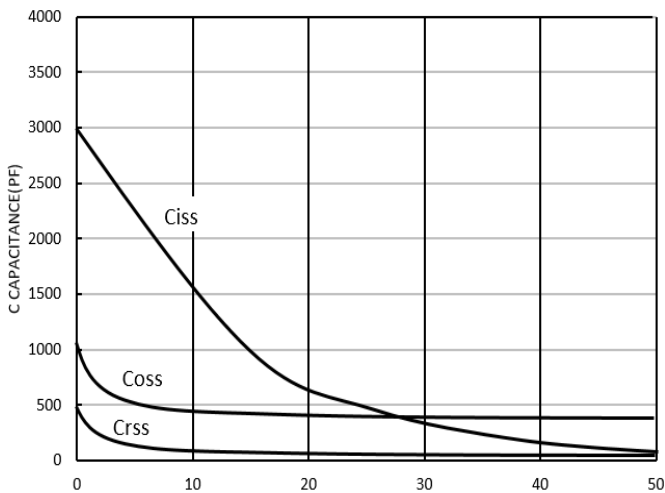

Figure5: Vds Drain-Source Voltage (V)

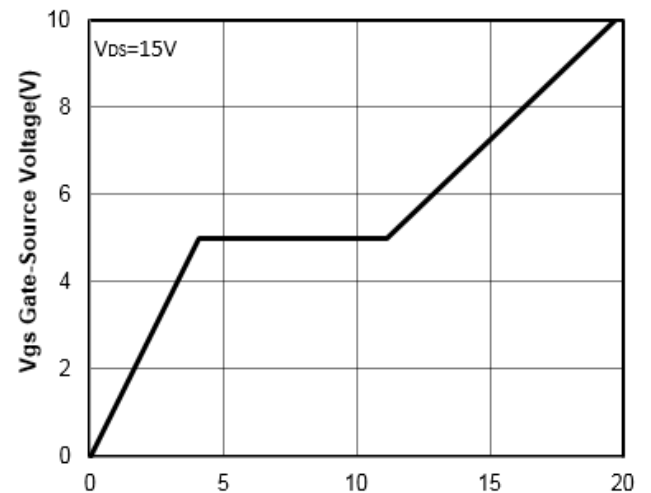

Figure6: Qg Gate Charge (nC)



650V/7A N-Channel Junction Power MOSFET

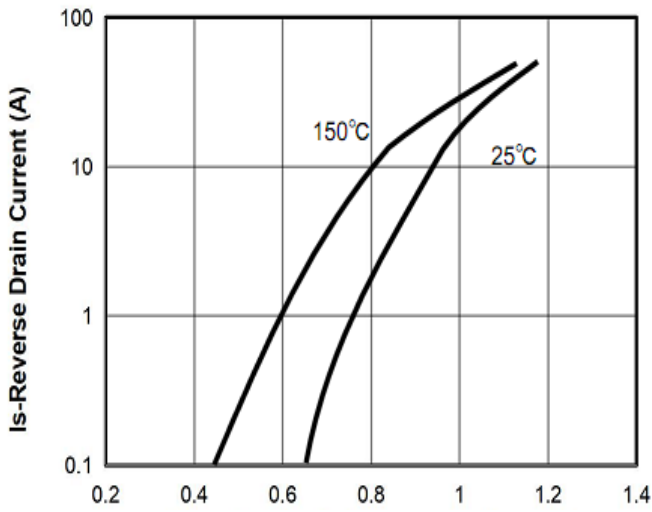

Figure7: Vsd Source-Drain Voltage (V)

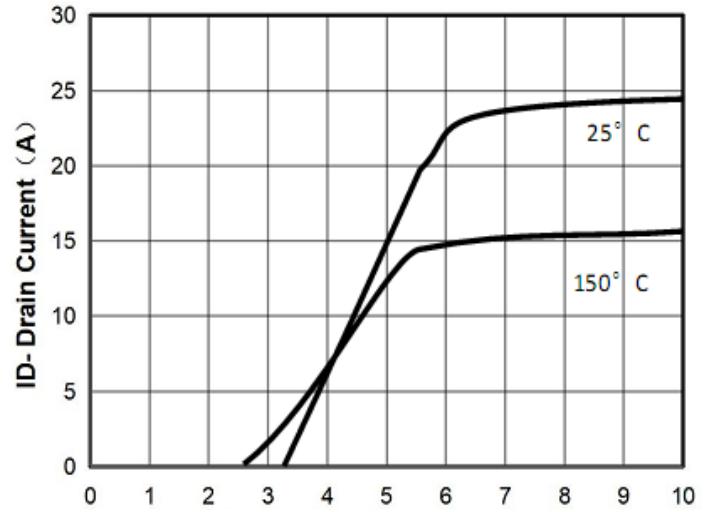

Figure8: Vgs Gate-Source Voltage (V)

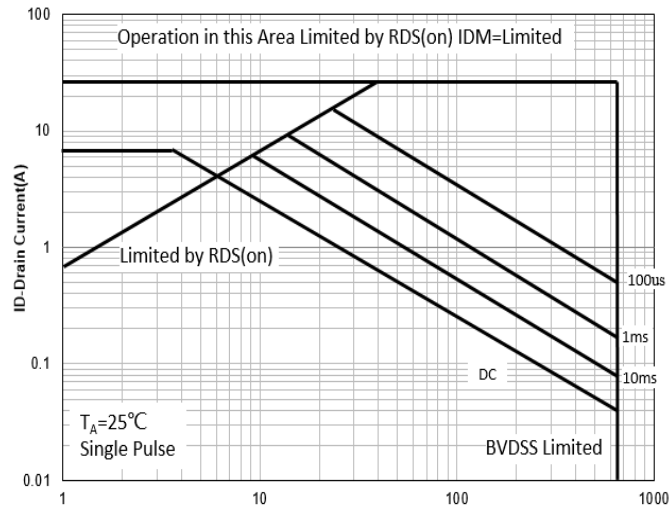

Figure9: VDS Drain-Source Voltage (V)

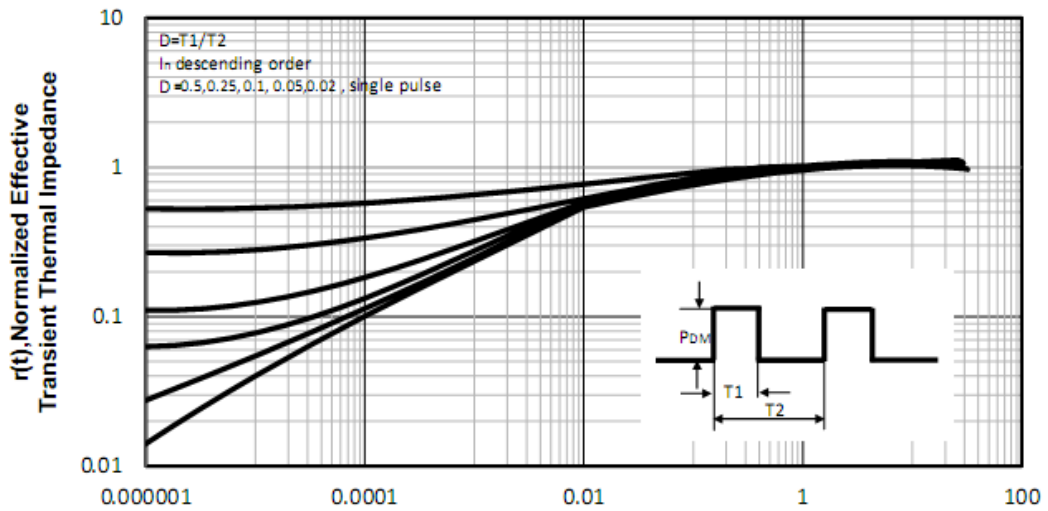

Figure10: Square Wave Pulse Duration (sec)

650V/7A N-Channel Junction Power MOSFET

Test Circuit and Waveform:

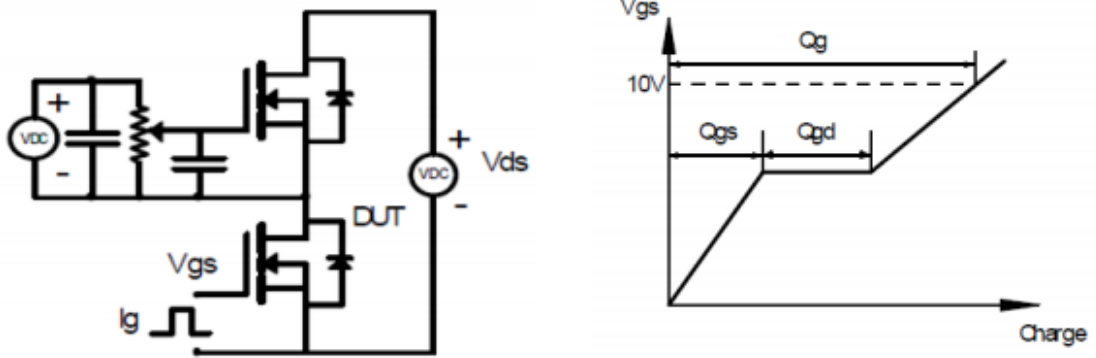

Figure A Gate Charge Test Circuit & Waveforms

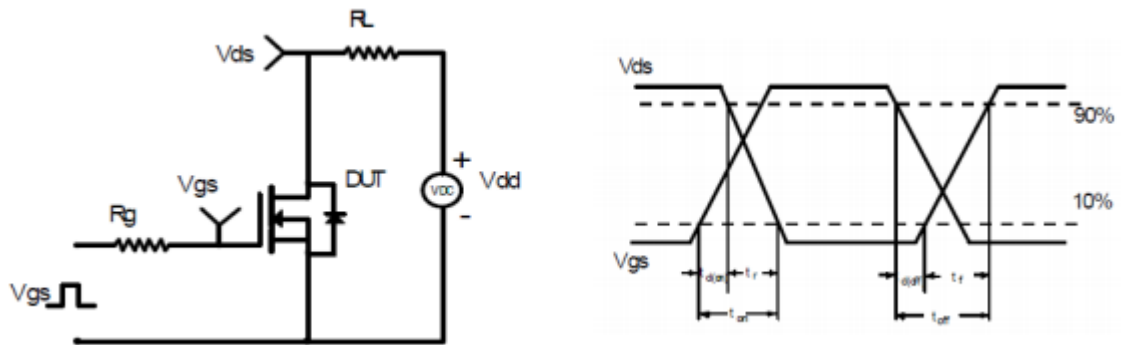

Figure B Switching Test Circuit & Waveforms

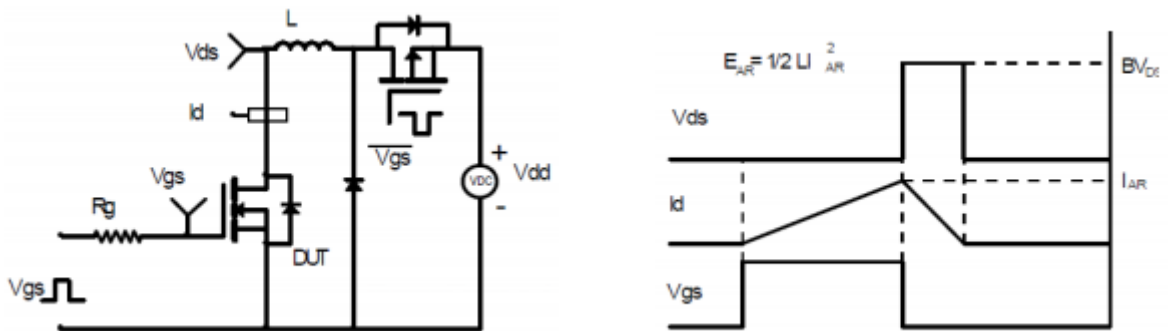
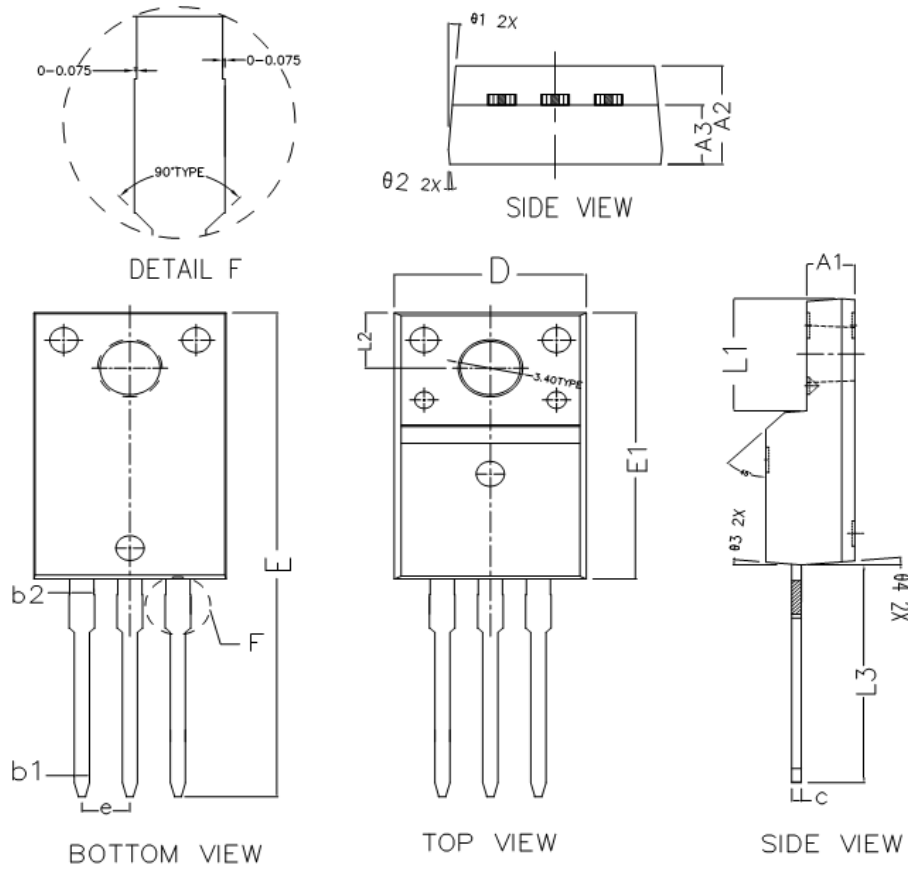

Figure C Unclamped Inductive Switching Circuit & Waveforms



650V/7A N-Channel Junction Power MOSFET

TO-220F Package Outline Dimensions (Units: mm)



COMMON DIMENSIONS (UNITS OF MEASURE IS mm)			
	MIN	NORMAL	MAX
A1	2.440	2.540	2.640
A2	4.600	4.700	4.800
A3	2.730	2.830	2.930
b1	0.750	0.800	0.850
b2	1.230	1.280	1.330
c	0.450	0.500	0.550
D	10.060	10.160	10.260
E	28.650	28.850	29.050
E1	15.770	15.870	15.970
e	2.54TYPE		
L1	6.68REF		
L2	3.30REF		
L3	12.830	12.980	13.130
theta1	5° TYPE		
theta2	5° TYPE		
theta3	5° TYPE		
theta4	5° TYPE		