



80V/100A N-Channel Advanced Power MOSFET

Features

- New technology for high voltage device.
- Low on-resistance and low conduction losses
- Small package
- Ultra Low Gate Charge cause lower driving requirements
- 100% Avalanche Tested

Applications

- Power factor correction (PFC)
- Switched mode power supplies(SMPS)
- Uninterruptible Power Supply (UPS)

BVDSS	80	V
ID	100	A
RDSON@VGS=10V	6.5	mΩ

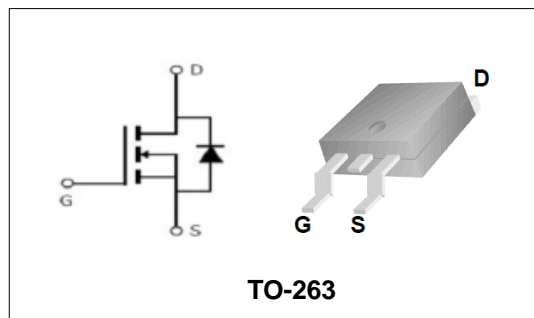

Order Information

Product	Package	Marking	Reel Size	Reel	Carton
PTY10HN08	TO-263	PTY10HN08	13inch	800PCS	6400PCS
			/	50PCS	5000PCS

Absolute Maximum Ratings

Symbol	Parameter	Rating	Unit	
Common Ratings (TC=25°C Unless Otherwise Noted)				
$V_{(BR)DSS}$	Drain-Source Breakdown Voltage	80	V	
V_{GS}	Gate-Source Voltage	±25	V	
T_J	Maximum Junction Temperature	150	°C	
T_{STG}	Storage Temperature Range	-55 to 150	°C	
I_S	Diode Continuous Forward Current	TC =25°C	97	A
Mounted on Large Heat Sink				
E_{AS}	Single Pulse Avalanche Energy (Note1)	313	mJ	
I_{DM}	Pulse Drain Current Tested (Silicon Limit) (Note2)	TC =25°C	400	A
I_D	Continuous Drain current	TC =25°C	100	A
P_D	Maximum Power Dissipation	TC =25°C	200	W
$R_{θJC}$	Thermal Resistance Junction-to- Case (Note3)	0.63	°C/W	
$R_{θJA}$	Thermal Resistance Junction-to- Ambient (Note3)	62.5	°C/W	



80V/100A N-Channel Advanced Power MOSFET

Symbol	Parameter	Condition	Min.	Typ.	Max.	Unit
Static Electrical Characteristics @ T_J = 25°C (unless otherwise stated)						
V _{(BR)DSS}	Drain- Source Breakdown Voltage	VGS=0V ID=250μA	80	--	--	V
I _{DSS}	Zero Gate Voltage Drain current	VDS=80V,VGS=0V	--	--	1	μA
I _{GSS}	Gate-Body Leakage Current	VGS=±25V,VDS=0V	--	--	±100	nA
V _{GS(TH)}	Gate Threshold Voltage	VDS=VGS,ID=250μA	2	3	4	V
R _{DS(ON)}	Drain-Source On-State Resistance (Note4)	VGS=10V, ID=50A	--	6.5	8.5	mΩ
Dynamic Electrical Characteristics @ T_J = 25°C (unless otherwise stated) (Note5)						
C _{iss}	Input Capacitance	VDS=50V, VGS=0V, F=1MHz	--	3175	--	pF
C _{oss}	Output Capacitance		--	440	--	pF
C _{rss}	Reverse Transfer Capacitance		--	268	--	pF
Q _g	Total Gate Charge	VDS=64V, ID=50A, VGS=10V	--	76	--	nC
Q _{gs}	Gate-Source Charge		--	21	--	nC
Q _{gd}	Gate-Drain Charge		--	24	--	nC
Switching Characteristics (Note5)						
t _{d(on)}	Turn-on Delay Time	VDS=40V, ID=50A, VGS=10V	--	49	--	nS
t _r	Turn-on Rise Time		--	64	--	nS
t _{d(off)}	Turn-off Delay Time		--	139	--	nS
t _f	Turn-off Fall Time		--	48	--	nS
Source- Drain Diode Characteristics @ T_J = 25°C (unless otherwise stated)						
V _{SD}	Forward on voltage	ISD=50A,VGS=0V	--	0.9	1.3	V

Note:

- Limited by T_{Jmax}, starting T_J = 25° C, R_G = 25Ω, V_D = 50V, V_{GS} = 10V. Part not recommended for use above this value.
- Repetitive Rating: Pulse width limited by maximum junction temperature.
- Surface Mounted on FR4 Board, t ≤ 10 sec.
- Pulse Test: pulse width ≤ 300 us, duty cycle ≤ 2%.
- Guaranteed by design, not subject to production testing.



80V/100A N-Channel Advanced Power MOSFET
Typical Characteristics

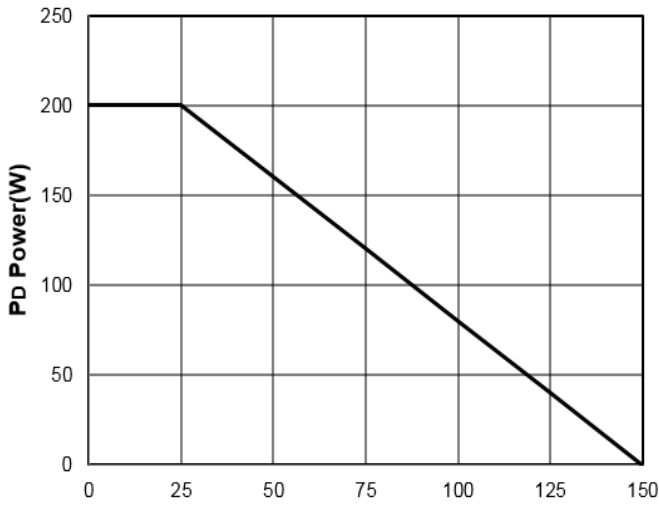

Figure1: T_j Junction Temperature (°C)

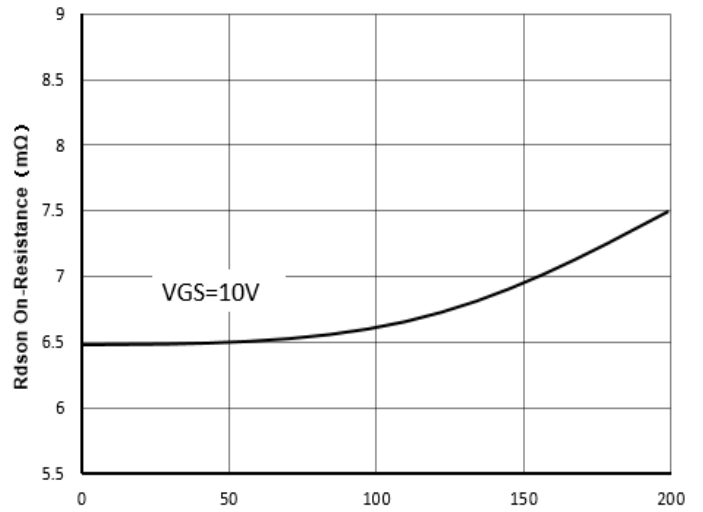

Figure2: I_d Drain Current (A)

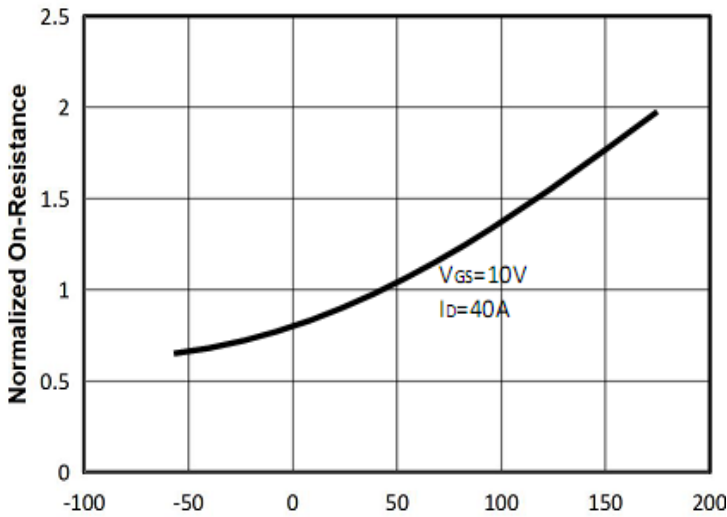

Figure3: T_j Junction Temperature (°C)

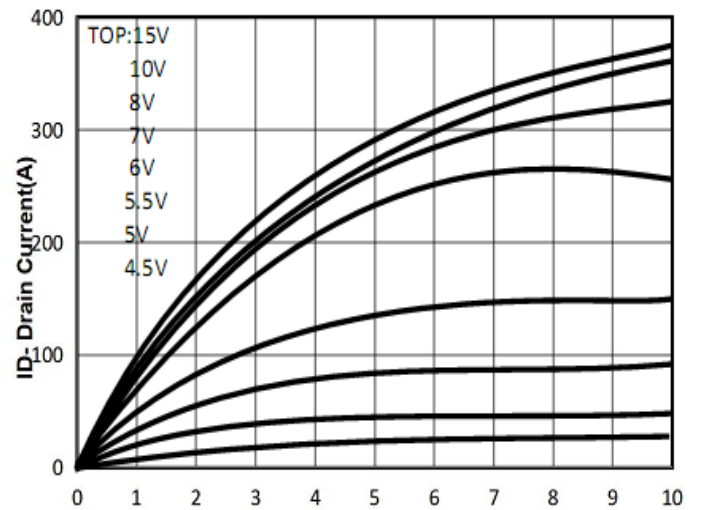

Figure4: V_{ds} Drain-Source Voltage (V)

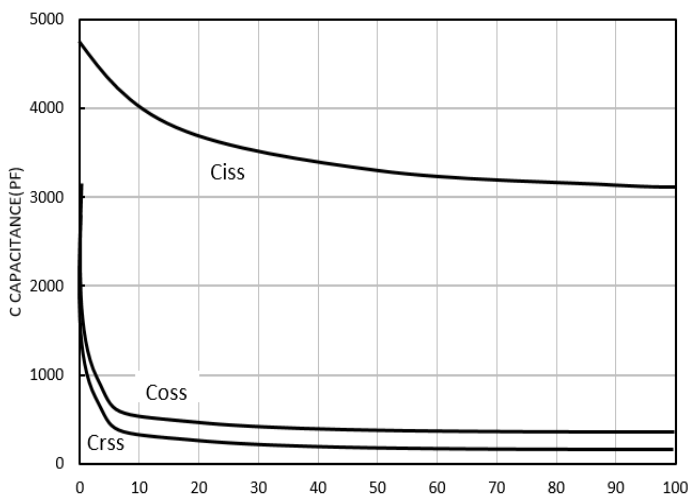

Figure5: V_{ds} Drain-Source Voltage (V)

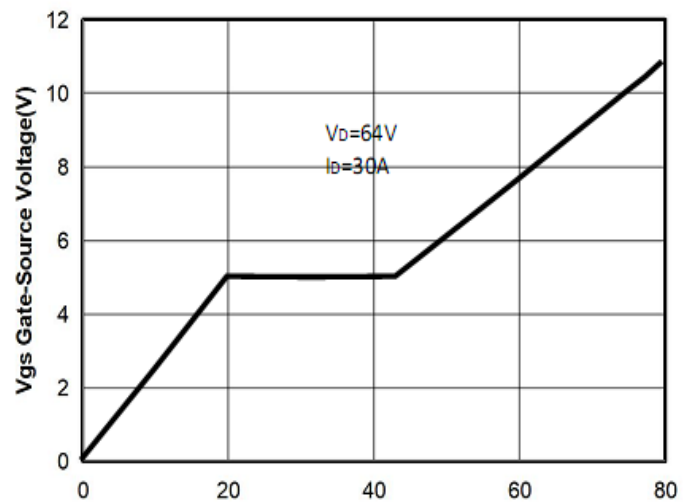

Figure6: Q_g Gate Charge (nC)



80V/100A N-Channel Advanced Power MOSFET

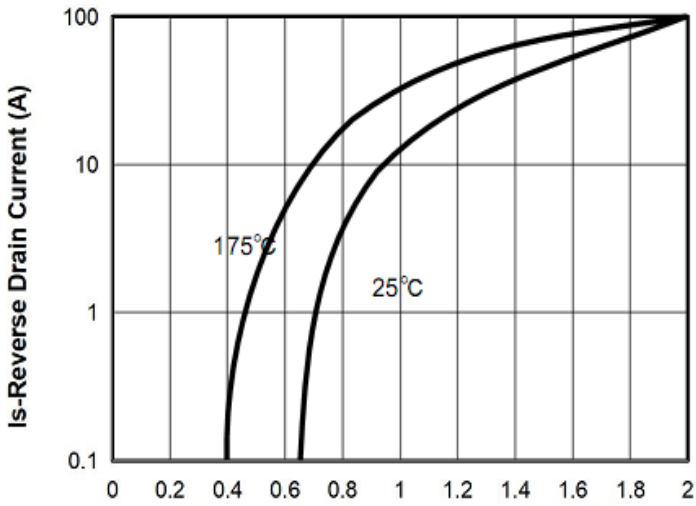

Figure7: Vsd Source-Drain Voltage (V)

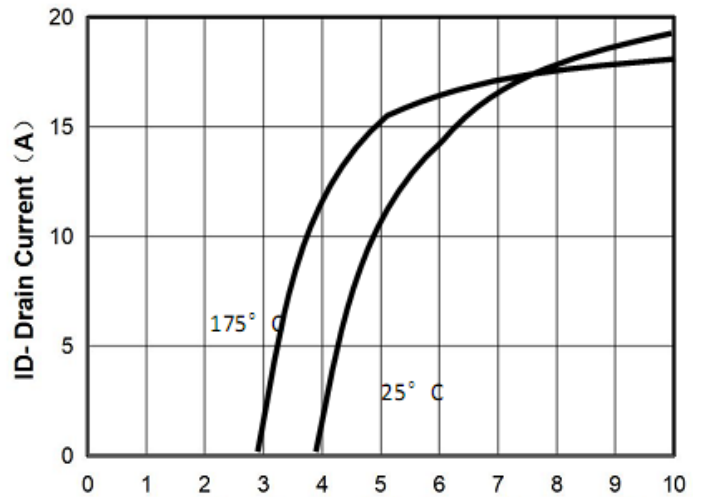

Figure8: Vgs Gate-Source Voltage (V)

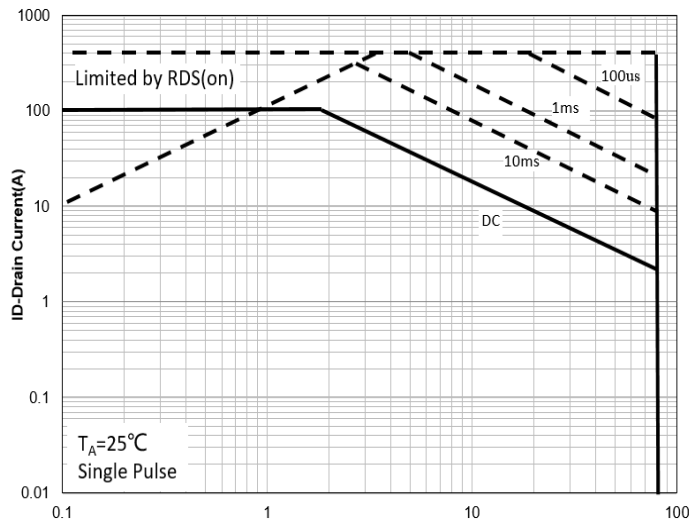

Figure9: Vds Drain-Source Voltage (V)

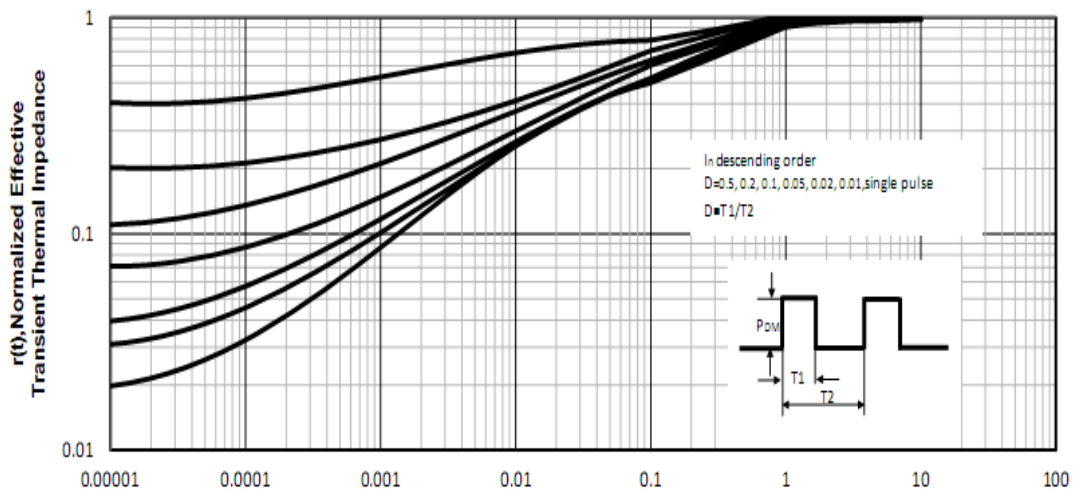

Figure10: Square Wave Pulse Duration (sec)

80V/100A N-Channel Advanced Power MOSFET

Test Circuit and Waveform:

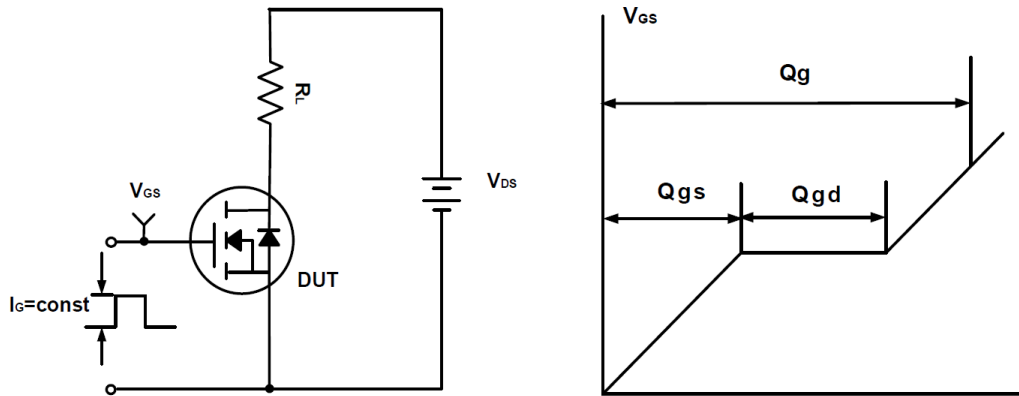

Figure A Gate Charge Test Circuit & Waveforms

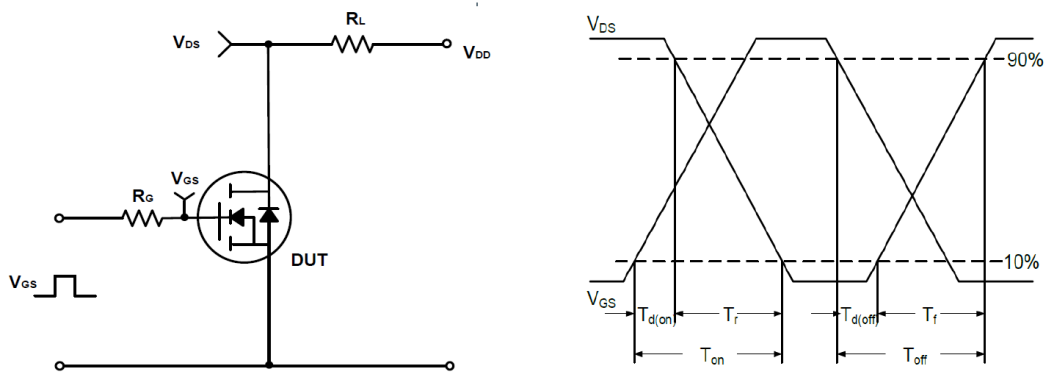

Figure B Switching Test Circuit & Waveforms

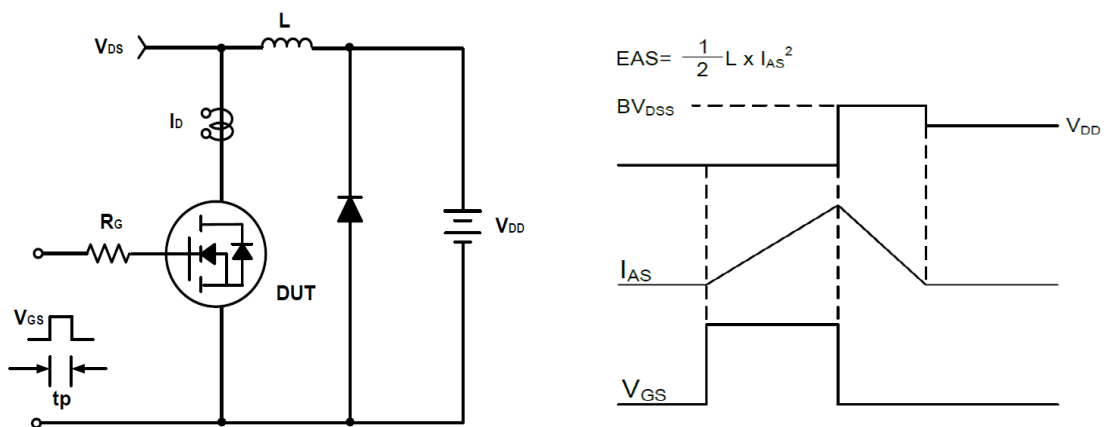
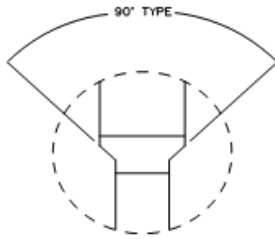

Figure C Unclamped Inductive Switching Circuit & Waveforms



80V/100A N-Channel Advanced Power MOSFET

TO-263 Package Outline Dimensions (Units: mm)



DETAIL F

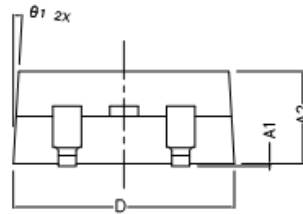

SIDE VIEW

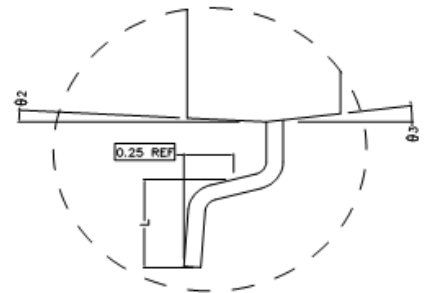

DETAIL G

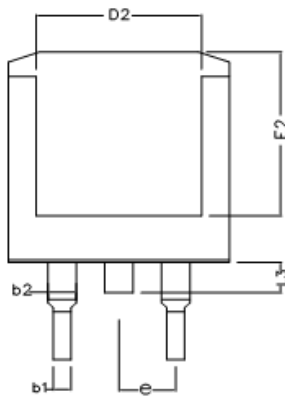

BOTTOM VIEW

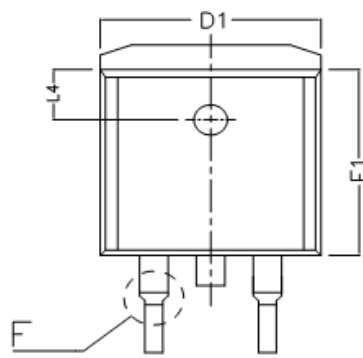

TOP VIEW

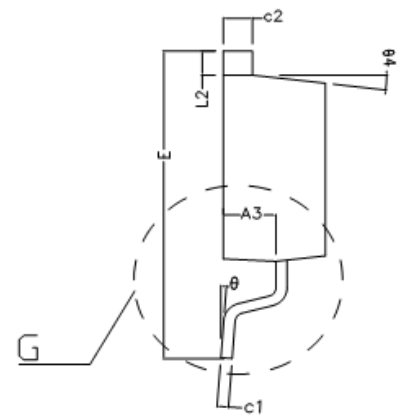

SIDE VIEW

COMMON DIMENSIONS (UNITS OF MEASURE IS mm)			
	MIN	NORMAL	MAX
A1	0.020	0.100	0.200
A2	4.470	4.570	4.670
A3	2.300	2.350	2.400
b1	0.750	0.800	0.850
b2	1.220	1.270	1.320
c1	0.450	0.500	0.550
c2	1.250	1.300	1.350
D	9.900	10.000	10.100
D1	9.880REF		
D2	7.400REF		
E	14.900	15.100	15.300
E1	9.000	9.100	9.200
E2	8.100REF		
e	2.540TYPE		
L	2.100	2.300	2.500
L2	1.100	1.200	1.300
L3	1.300	1.500	1.700
L4	2.50 TYPE		
theta1	3° TYPE		
theta2	3° TYPE		
theta3	7° TYPE		
theta4	7° TYPE		
theta	0 ~ 8°		